

Modulating damper actuator for adjusting dampers in technical building installations

- Air damper size up to approx. 4 m<sup>2</sup>
- Nominal torque 20 Nm
- Nominal voltage AC/DC 24 V
- Control modulating DC (0)2...10 V
- Position feedback DC 2...10 V

**Technical data**

<b>Electrical data</b>	Nominal voltage	AC/DC 24 V
	Nominal voltage frequency	50/60 Hz
	Nominal voltage range	AC 19.2...28.8 V / DC 19.2...28.8 V
	Power consumption in operation	2 W
	Power consumption in rest position	0.4 W
	Power consumption for wire sizing	4 VA
	Connection supply / control	Cable 1 m, 4 x 0.75 mm <sup>2</sup>
	Parallel operation	Yes (note the performance data)
<b>Functional data</b>	Torque motor	Min. 20 Nm
	Positioning signal Y	DC 0...10 V
	Positioning signal Y note	Input impedance 100 kΩ
	Operating range Y	DC 2...10 V
	Position feedback U	DC 2...10 V
	Position feedback U note	Max. 1 mA
	Position accuracy	±5%
	Direction of motion motor	selectable with switch 0 / 1
	Direction of motion note	Y = 0 V: At switch position 0 (ccw rotation) / 1 (cw rotation)
	Manual override	with push-button, can be locked
	Angle of rotation	Max. 95°
	Angle of rotation note	can be limited on both sides with adjustable mechanical end stops
	Running time motor	150 s / 90°
	Sound power level motor	45 dB(A)
Spindle driver	Universal spindle clamp reversible 10...20 mm	
Position indication	Mechanically, pluggable	
<b>Safety</b>	Protection class IEC/EN	III Safety Extra-Low Voltage (SELV)
	Protection class UL	UL Class 2 Supply
	Degree of protection IEC/EN	IP54
	Degree of protection NEMA/UL	NEMA 2, UL Enclosure Type 2
	EMC	CE according to 2014/30/EU
	Certification IEC/EN	IEC/EN 60730-1 and IEC/EN 60730-2-14
	Certification UL	cULus according to UL 60730-1A, UL 60730-2-14 and CAN/CSA E60730-1:02
	Mode of operation	Type 1
	Rated impulse voltage supply / control	0.8 kV
	Control pollution degree	3
Ambient temperature	-30...50°C	
Non-operating temperature	-40...80°C	
Ambient humidity	95% r.h., non-condensing	
Maintenance	Maintenance-free	
<b>Weight</b>	Weight	1.1 kg

**Safety notes**

- The device must not be used outside the specified field of application, especially not in aircraft or in any other airborne means of transport.

## Safety notes

- Outdoor application: only possible in case that no (sea)water, snow, ice, insolation or aggressive gases interfere directly with the actuator and that is ensured that the ambient conditions remain at any time within the thresholds according to the data sheet.
- Only authorised specialists may carry out installation. All applicable legal or institutional installation regulations must be complied during installation.
- The device may only be opened at the manufacturer's site. It does not contain any parts that can be replaced or repaired by the user.
- Cables must not be removed from the device.
- To calculate the torque required, the specifications supplied by the damper manufacturers concerning the cross-section, the design, the installation site and the ventilation conditions must be observed.
- The device contains electrical and electronic components and must not be disposed of as household refuse. All locally valid regulations and requirements must be observed.

## Product features

<b>Mode of operation</b>	The actuator is connected with a standard modulating signal of DC 0...10V and drives to the position defined by the positioning signal. Measuring voltage U serves for the electrical display of the damper position 0...100% and as slave control signal for other actuators.
<b>Simple direct mounting</b>	Simple direct mounting on the damper spindle with an universal spindle clamp, supplied with an anti-rotation device to prevent the actuator from rotating.
<b>Manual override</b>	Manual override with push-button possible (the gear is disengaged for as long as the button is pressed or remains locked).
<b>Adjustable angle of rotation</b>	Adjustable angle of rotation with mechanical end stops.
<b>High functional reliability</b>	The actuator is overload protected, requires no limit switches and automatically stops when the end stop is reached.

## Accessories

	Description	Type
<b>Electrical accessories</b>	Auxiliary switch, add-on, 1 x SPDT	S1A
	Auxiliary switch, add-on, 2 x SPDT	S2A
	Feedback potentiometer 140 Ohm, add-on	P140A
	Feedback potentiometer 140 Ohm, add-on, grey	P140A GR
	Feedback potentiometer 200 Ohm, add-on	P200A
	Feedback potentiometer 500 Ohm, add-on	P500A
	Feedback potentiometer 500 Ohm, add-on, grey	P500A GR
	Feedback potentiometer 1 kOhm, add-on	P1000A
	Feedback potentiometer 1 kOhm, add-on, grey	P1000A GR
	Feedback potentiometer 2.8 kOhm, add-on	P2800A
	Feedback potentiometer 2.8 kOhm, add-on, grey	P2800A GR
	Feedback potentiometer 5 kOhm, add-on	P5000A
	Feedback potentiometer 5 kOhm, add-on, grey	P5000A GR
	Feedback potentiometer 10 kOhm, add-on	P10000A
	Feedback potentiometer 10 kOhm, add-on, grey	P10000A GR
	Signal converter voltage/current, supply AC/DC 24V	Z-UIC
	Digital position indicator for front-panel mounting, 0...99%, front mass 72 x 72 mm	ZAD24
	Range controller for wall mounting, adjustable electron. Min./max. angle of rotation limitation	SBG24
	Positioner for wall mounting, range 0...100%	SGA24
	Positioner in a conduit box, range 0...100%	SGE24
Positioner for front-panel mounting, range 0...100%	SGF24	
Positioner for wall mounting, range 0...100%	CRP24-B1	

## Accessories

	Description	Type
<b>Mechanical accessories</b>	Actuator arm, for standard spindle clamp (reversible) K-SA	AH-20
	Shaft extension 250 mm for CrNi (INOX)	AV12-25-I
	Shaft extension 250 mm, for damper spindles $\varnothing$ 8...25 mm	AV8-25
	Angled ball joint with M8, suitable for damper crank arms KH8	KG8
	Straight ball joint with M8, suitable for damper crank arms KH8	KG10A
	Damper crank arm, for damper spindles	KH8
	Spindle clamp, one side for NM..A, SM..A	K-ENSA
	Spindle clamp, one side for SM..A	K-ENSA-I
	Spindle clamp, reversible for SM..A and NMQ..	K-SA
	Universal mounting bracket 180 mm	Z-ARS180
	Universal mounting bracket 230 mm	Z-ARS230
	Angle of rotation limiter, for K-NA	20334-00001
	Form fit insert 10x10 mm, for NM..A / SM..A	ZF10-NSA
	Form fit insert 12x12 mm, for NM..A / SM..A	ZF12-NSA
	Form fit insert 15x15 mm	ZF15-NSA
	Form fit insert 16x16 mm, for NM..A / SM..A	ZF16-NSA
	Mounting kit for linkage operation, SM..A for flat installation	ZG-SMA
	Position indication for LM..A, NM..A, SM..A, GM..A	Z-PI
	Base plate extension from SM..A to SM../AM../SMD24R	Z-SMA

## Electrical installation



### Notes

- Connection via safety isolating transformer.
- Parallel connection of other actuators possible. Observe the performance data.



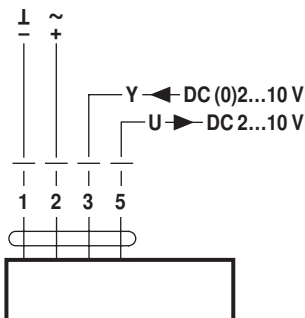

## Wiring diagrams

AC/DC 24 V, modulating



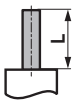

Dimensions [mm]

Spindle length

		Min. 48
		Min. 20

Clamping range

			
	10...20	≥10	≤20
<b>CrNi (INOX)</b>	12...20	≥10	≤20

With utilisation of a round spindle made of CrNi (INOX): Ø 12...20 mm

Dimensional drawings

